



CHINEE ROADWAY SAFETY CO.LTD

中国交通安全设施生产基地

THE PRODUCTION BASE OF TRAFFIC SAFETY IN CHINA

中国交通安全设施品牌领跑者

THE LEADING BRAND OF TRAFFIC SAFETY IN CHINA

外贸公司信赖合作伙伴

IDEAL PARTNER OF TRADING COMPANIES

成为全球知名的交通安全设施供应商

TO BE THE FAMOUS SUPPLIER OF TRAFFIC SAFETY WORLDWIDE

致力于人类安防事业

DELICATE TO THE CAUSE OF HUMAN SECURITY



**Chinee Roadway Safety Co.Ltd**

Add: 6F,ShunJing Trade Center,No.855,Industrial Avenue  
South, Haizhu District, Guangzhou, China(Mainland)

[www.china-roadwaysafety.com](http://www.china-roadwaysafety.com)

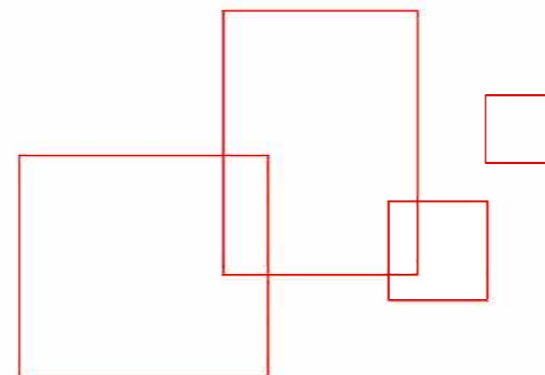



### Company Mission

- Survive by quality
- Seeking innovation through technology
- Seeking development through sincere service

## Company Profile

Excellent product with exquisite craftsmanship

Chinee Roadway Safety Co. Ltd. Is an innovative company dedicated to traffic safety facilities, we always adhere to the concept of “innovation-driven, quality first”, committed to providing products in line with the latest safety standards for the global market. Since the establishment of the company, we continue to adapt to the changes of domestic and foreign markets, relying on excellent research and development capabilities and advanced production technology, continue to introduce new products with market competitiveness to meet the diversified needs of customers.

Our products are widely used in transportation, industry, construction and other fields, covering traffic cones, rubber speed bumps, corner guards, crowd control columns, warning columns, spikes, water guardrail, anti-collision barrels, warning signs, warning wetland signs, wheel baffles and other traffic safety facilities. Each product is subjected to rigorous quality testing to ensure reliability and durability in a variety of complex environments.

We not only focus on product innovation, but also focus on the long-term development of the brand. Through continuous improvement of the production process and service system, Chinee Roadway Safety Co. Ltd. Has established an excellent brand image in the industry. We remain committed to quality and are committed to becoming a global leader in traffic safety. In the future, we will continue to carry forward the spirit of innovation and continue to expand the product line to meet the growing market demand.

In addition, the company is committed to sustainable development, actively promote the application of green manufacturing and environmentally friendly materials, and strive to improve product performance while reducing the impact on the environment. We believe that only by continuous innovation and improvement can we maintain a leading position in the fierce market competition and become a trusted partner.

Chinee Roadway Safety Co. Ltd. We will continue to be customer-oriented, constantly optimize products and services, and provide safer and more efficient traffic safety solutions for customers around the world. Our goal is to become not only in the Chinese market, but also in the global traffic safety equipment brand benchmarking enterprises.

# Contents 目录

	安全围栏 Safety Fences	01		道坡 Kerb Ramps	28
	PE 路锥 PE Traffic Cones	03		防撞块 D-Type Dock Bumper	28
	PVC 路锥 PVC Traffic Cones	05		橡胶护角/塑料护角 Corner Guards	29
	EVA路锥 EVA Cones	07		塑料护栏, 水马, 防撞桶 Safety Barriers/Water Barriers/Plastic Barrier	31
	连接杆 Cone Bar	07		铁马铁护栏 Metal Barriers	33
	橡胶路锥 Rubber Traffic Cones	07		伸缩护栏 Que Manager/Queue Belt Crowd Control Barrier	34
	PE路锥 PE Cones	08		广角镜 Convex Mirrors	35
	伸缩路锥 Collapsible Cones	09		告示牌 Safety Floor Signs	36
	弹性警示柱 Flexible Posts	11		防眩板 Antiglare Panel	36
	1.1M 警示柱/诱导标 Delineators	13		路障灯/太阳能路障灯 Flasher lights/Solar Barricade Lights	37
	塑料警示板 Vertical Panels	13		电池 Battery:6V 4R25	39
	链条 Plastic Chains	14		警示带 Marking Tape/Barricade Tape/Warning Tapes	40
	减速带 Speed Bumps/Speed Humps	15		反光背心 Safety Vests	41
	盲道 Blind Road Brick	17		分道体 Lane Separator	43
	线槽减速带 Cable Protectors	19		道钉 Road Studs/Road Reflector	44
	橡胶减速垫 Rubber Speed Cushions	22		指挥棒 Traffic Batons/Traffic Wands	45
	定位器 Parking Curbs/Parking Blocks/Wheel Stoppers	23		警示三角牌 Safety Triangles	46
	导向板, 防撞块 Wall Protectors	26		安全帽 Safety Helmets/Safety Caps/Hard Hats	47
	挡车刹 Wheel Chocks	27			

## 安全围栏 Underground Warning Mesh

Underground warning extruded mesh / Signal mesh / Underground warning mesh for marking underground

### Product Description

- 1.Warning / detection:Underground pipes and electric lines,oil pipes and communication cable.
- 2.CHIXIN Signal Fence is an underground warning mesh used for the marking and location of buried pipes and cables.It is laid in the excavation trench about 500mm above the cable or pipe line.During future re-excavation works,the highly visible band will alert excavators to the pipe/ cables below.
- 3.CHIXIN manufactures underground warning meshes for applications in civil engineering that require buried services and utilities to be marked and protected when buried and that provide a visual warning to rogue excavations.

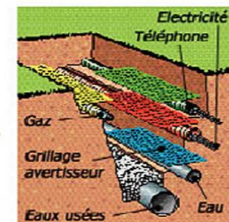
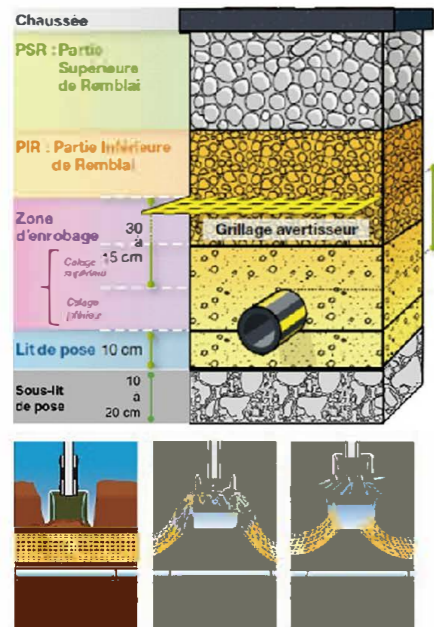
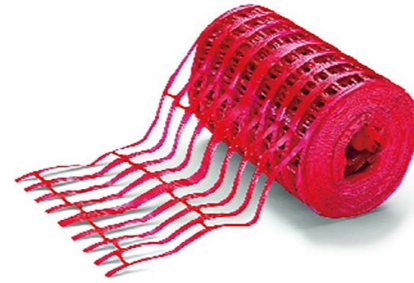
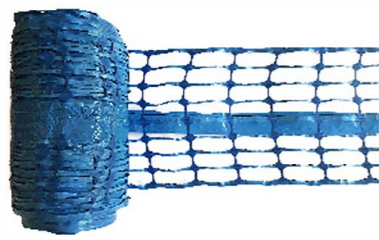

Photo	Model	Mesh Size(mm)	Weight(g/m <sup>2</sup> )	Width(m)	Color
	CC-BR060-10040	100 × 40	60	0.3	Orange/Yellow/ Blue/Green
	CC-BR080-10040		80		

## 安全围栏 Safety Fence

### Product Description

1. BR type is a UV stabilized fence with rectangular mesh openings designed.
2. Strong HDPE plastic resists wind damage and remains flexible in freezing temperatures.
3. Slow wind and create drifts for snow storage or where they will not interfere with roadways, driveways or runways.
4. Flexible and easy to handle.



Safety Fence BR Series

Photo	Model	Mesh Size(mm)	Weight(g/m <sup>2</sup> )	Width(m)	Color
	CC-BR060-10040	100 × 40	60	1/1.2	Orange/Yellow/ Blue/Green
	CC-BR080-10040		80		
	CC-BR100-10040		100		
	CC-BR120-10040		120		
	CC-BR060-07026	70 × 26	60	1/1.2	Orange/Yellow/ Blue/Green
	CC-BR100-07026		100		



Safety Fence SR Series

Photo	Model	Mesh Size(mm)	Weight(g/m <sup>2</sup> )	Width(m)	Color
	CC-SR060-06535	65 × 35	60	1/1.2	Orange/Yellow/ Blue/Green
	CC-SR080-06535		80		
	CC-SR100-06535		100		
	CC-SR120-06535		120		
	CC-SR140-06535		140		

### 塑料 (PE) 路锥

Features: impact-resistant, sun-proof, cold-resistant and good reflective effect.

Material: cone PE, base rubber. Added high-quality pigments and anti-ultraviolet ingredients to make the color more stable, lasting and bright.

Reflective material: High-brightness reflective film, at night, when the light shines on it, it can emit dazzling light, allowing the driver to see clearly, drive safely, and avoid dark obstacles.



Model 型号	Height 高度 (cm)	Base Size 底座尺寸 (cm)	Reflective Collars Size 反光带尺寸 (cm)	Weight 重量(KG)	PCS/M³ 包装数量	Loading Quantity 装柜数量 (20')
CC-A01	50	28 X 28	11	1.5	400	12160
CC-A02	75	38 X 38	22	2.5	200	6000
CC-A04	100	49 X 49	32	5.0	110	2500

Remark: Reflective Collars Size, Product Weight and Colors could all be customized.  
备注: 反光带尺寸、产品重量、颜色都可订制。

### PE Traffic Cone

#### Product Description

1. Available in three sizes: 50cm, 75cm and 1m.
2. Blow moulded body for strength with rubber base, interlocking two-part design.
3. Body can be embossed with company names or logos.
4. Heavy duty, 100% recycled cones designed for maximum stability, easy of handling and storage.
5. It may also be fitted with warning lights for increasing visibility.



Model 型号	Height 高度 (cm)	Base Size 底座尺寸 (cm)	Reflective Collars Size 反光带尺寸 (cm)	Weight 重量(KG)	PCS/M³ 包装数量
CC-A02-With Ring	75	38 X 38	22	2.5	130
CC-A03	75	38 X 38	12+12	2.5	200
CC-A05	50	26 X 26	10	0.45	350
CC-A05-1	50	29 X 29	10	1	300
CC-A06	70	33 X 33	14	2.2	200
CC-A07	75	43 X 43	13.5+13.5+13.5	4.5	120
CC-A08	75	38 X 38	43	3	150
CC-A08-1	70	35 X 35	42	1 / 3	150
CC-A08-2	68	31 X 31	38	0.6 / 2.5	150
CC-A43	75	42 X 42	14.5+14.5	3.9	130
CC-A44	75	44 X 44	30	4 / 4.5	130

## Orange Fluorescent PVC Traffic Cone

### Product Description

**Performance:** It can be twisted and stepped on 180 degrees, and the top touches the ground and can quickly return to its original shape. Good flexibility can withstand vehicle rolling and impact. Good weather resistance, no deformation at high temperature of 65, no cracking at low temperature of -30°C. The reflective effect is very strong, and it has a good warning effect both during the day and at night. Anti-ultraviolet, not easy to age, and durable.

**Material:** 100% environmentally friendly modified PVC.

**Color:** fluorescent orange, red, blue, yellow, green, mortar (can be customized)

- 1.All vinyl construction assures durability and flexibility in all weather conditions.
- 2.Long lasting brilliant fluorescent color provides high visibility protection.
- 3.Ultraviolet stabilized color provides maximum resistance to fading.
- 4.High density base creates low center of gravity for maximum stability.
- 5.Available in various weights and styles to meet specific needs.
- 6.Options, such as stenciling, hot stamping, reflective collars, or flagadapters are available.

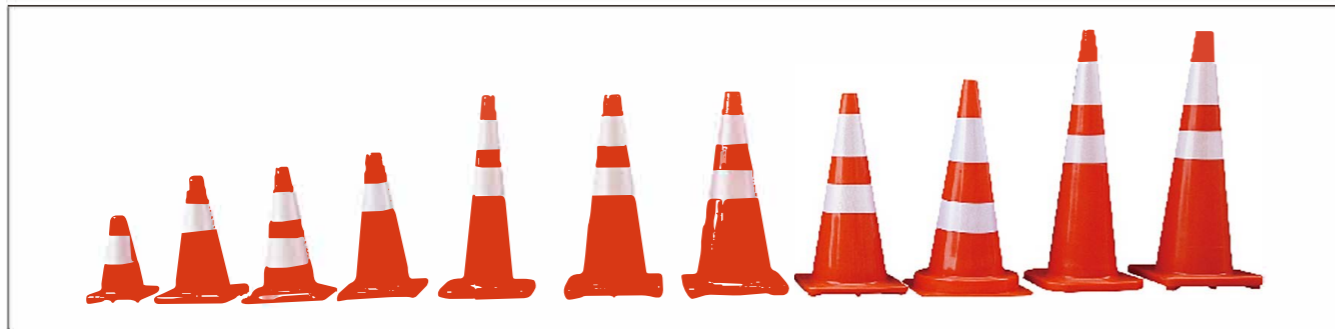

Model 型号	Height 高度 (cm)	Base Size 底座尺寸 (cm)	Reflective Collars Size 反光带尺寸 (cm)	PCS/M <sup>3</sup> 包装数量	Loading Quantity 装柜数量 (20')
CC-A30	30	21X21	As requested ( 根据要求 )	650	19000
CC-A45	45	28X28	10 or as requested	390	11000
CC-A47	47	30X30	10+10 or as requested	320	11000
CC-A50	50	28X28	10+10 or as requested	375	11000
CC-A70	70	35X35	10+10 or as requested	170	4800
CC-A70-1	70	33X33	10+10 or as requested	170	4800
CC-A75	75	40X40	10+10 or as requested	110	1820
CC-A90	90	36X36	10+10 or as requested	100	3000
CC-A301	50	38.5X38.5	As requested ( 根据要求 )	380	/
CC-A302	71	35X35	As requested ( 根据要求 )	/	/

## Black Base PVC Traffic Cone

### Product Description

- 1.Injection molded traffic cones don't stick together.
- 2.Interlocking design secures fluorescent portion of cone to recycled black PVC base.
- 3.Bright fluorescent red/orange traffic cones with UV inhibitors to resist fading.
- 4.Superior flexibility in heat and cold – PVC traffic cones bounce back from an impact.
- 5.Cleated black bases grip the road, while wide body design ensures stability.

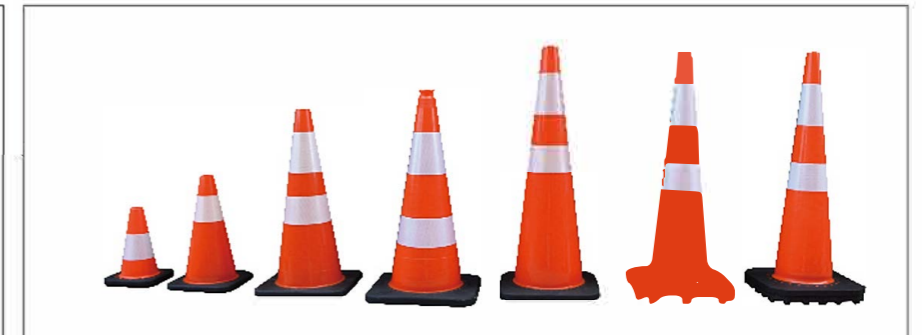

Model 型号	Height 高度 (cm)	Base Size 底座尺寸 (cm)	Reflective Collars Size 反光带尺寸 (cm)	PCS/M <sup>3</sup> 包装数量	Loading Quantity 装柜数量 (20')
CC-PV30	30	22X22	As requested ( 根据要求 )	650	17500
CC-PV45	45	27X27	10 or as requested	390	9280
CC-PV70	70	36X36	15+10 or as requested	170	3420
CC-PV75	75	40X40	15+10 or as requested	155	2880
CC-PV90	90	36X36	15+10 or as requested	100	2880
CC-PV91	90	36X36	15+10 or as requested	130	2880

## EVA / Rubber Traffic Cone

### 特点:

- 1.EVA路锥由EVA材料制作而成，耐压，可弹性强，耐晒、耐水、耐老化，耐用；
- 2.橡胶路锥具有耐撞击、防日晒、耐寒、不龟裂、不变色等优点。同时具有反光效果好，弹性强、不起皱等特点；
- 3.高亮反光膜，在夜间，灯光打在上面，能发出耀眼的光，让司机清晰可见，安全驾驶，躲避障碍。

### Product Description

- 1.EVA Traffic Cone is made of high quality EVA with rubber base,it is pressureproof, strong elasticity,anti-sunburn, waterproof, anti-ageing and highly durable.
- 2.Rubber Traffic Cone is made of 100% Rubber,it is formed in one piece and flexibility.
- 3.It may also be fitted with flashing lights for increasing visibility.



Model 型号	Material 材质	Height 高度 (cm)	Base Size 底座尺寸 (cm)	Reflective Collars Size 反光带规格 (cm)
CC-A13	Rubber	50	35x35	41
CC-A14	Rubber	70	38x38	56
CC-A55	EVA	50	32.5x32.5	14
CC-A56	EVA	70	42.5x42.5	14+4.5
CC-A58	EVA	70	42.5x42.5	41.5
CC-A102	Rubber	100	49x49	12+14.5+14.5

## Cone Bar

### Product Description

- 1.Our Cone Bar converts traffic cones into a pedestrian barricade in seconds.
- 3.Reusable, highly reflective at night, and it creates true work-site traffic control.

- 2.Reflective, lightweight & portable.



Model (型号) :CC-IR01  
Retractable  
Size:(L)200cm x(DIA)3.5cm



Model (型号) :CC-IR02  
Non-retractable  
Size:(L)200cm x(DIA)3.5cm



Reflective, expandable and versatile cone bar!

## PE Traffic Cone

### 特点:

- 1.产品材料为环保PE，无毒无味。具有很好的韧性，耐水、耐老化、使用寿命长。
- 2.产品适用于体育场，学校，单位，机关团体举行大型活动，小区停车等。

### Product Description

- 1.This item is made of non-toxic,environmentally friendly PE.which enables good flexibility,water-proof and ageing resistance.
- 2.Suitable for schools and other organisations to hold activities,as well as car parking in real estates.



Model 型号	Height 高度 (cm)	Base Size 底座尺寸 (cm)	Weight 重量(KG)
CC-A201	17	13 X 13	0.04
CC-A202	22.5	13 X 13	0.04
CC-A203	23.5	14 X 14	0.07
CC-A204	28	14.5 X 14.5	0.12
CC-A205	29	23	0.18
CC-A206	29	21.5 X 21.5	0.16
CC-A208	38	20 X 20	0.26
CC-A209	47	21 X 21	0.38
CC-A210	35.5	20.5 X 20.5	0.26
CC-A211	50	23 X 23	0.38



Model (型号) :CC-IR03  
Length : 1000mm  
Dia: 20mm

一般称为路障，足球标志筒，用于体育场，或者室内等。

## Collapsible Cones / Retractable Traffic Cones

### Product Description

1. Collapses flat for easy storage, it can be stored easily in a car trunk, utility truck, or tool box.
2. Made of durable nylon, with reflective stripes.
3. With LED light in the bottom of the cones or on the top of the cones, over 55cm height it can be detached and stored in the base of the cone.
4. Includes the white box that holds the cone and light, it also could be packed with color box or bag.
5. It also could add rubber feet to resist moving from high winds or passing cars & trucks.
6. Perfect for emergency responders, Fire/EMS or simply as an emergency traffic cone kit for motorists.



ABS材料底座

Collapsible Cone with ABS Base

CC-RUB70

CC-RUB90

Collapsible Cone with Rubber Base



Model 型号	Height 高度 (cm)	Base Size 底座尺寸 (cm)	PCS/CTN 装箱数量	G.W/N.W 毛净重(KG)	MEAS 箱规(cm)
CC-AB40	40	24.4 X 24.4 X 3.75	20	10.0/12.0	52 X 26.5 X 44.5
CC-AB45	45	24.4 X 24.4 X 3.75	20	10.6/12.6	52 X 26.5 X 44.5
CC-AB50	50	24.4 X 24.4 X 3.75	20	11.4/13.4	52 X 26.5 X 44.5
CC-AB55	55	30.5 X 30.5 X 5	10	9.3/11.3	60 X 32.5 X 33
CC-AB60	60	30.5 X 30.5 X 5	10	9.7/11.7	60 X 32.5 X 33
CC-AB65	65	30.5 X 30.5 X 5	10	10.1/12.1	60 X 32.5 X 33
CC-AB70	70	30.5 X 30.5 X 5	10	10.5/12.5	60 X 32.5 X 33
CC-RUB70	70	38 X 38	5	20/21	40 X 28 X 40
CC-RUB90	90	38 X 38	5	21/22	40 X 28 X 40

## Telescopic traffic cone

Features: it has the advantages of good elasticity, small size, easy to carry, etc., and an LED warning light can be installed on the top.

Material: fluorescent cloth; Reflective material; CE certified reflective tape;

Packing: PP bag + white box, each in one box.

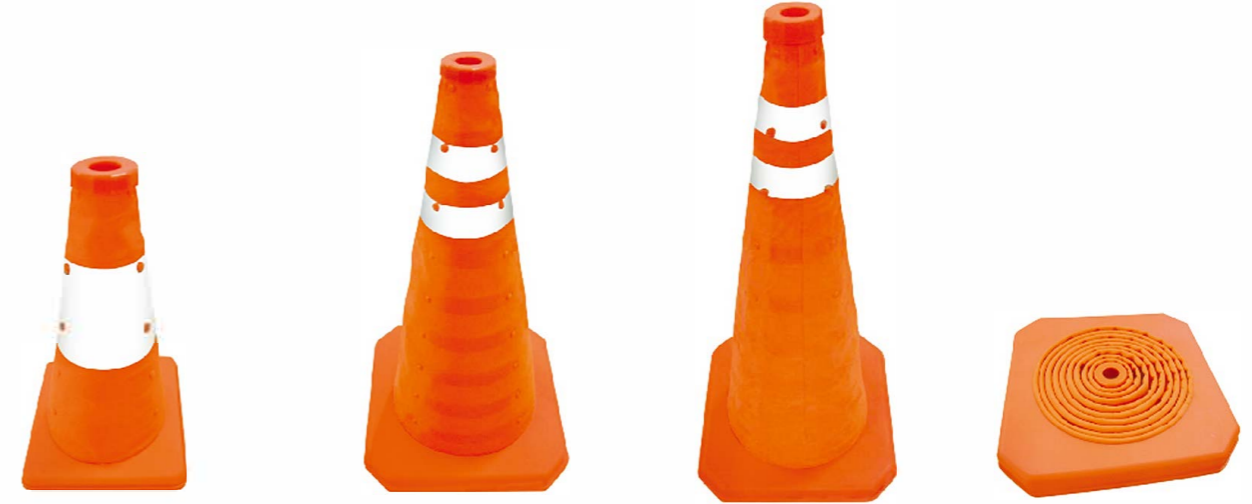

PP材料底座

Collapsible Cone with PP Base

Model 型号	Height 高度 (cm)	Base Size 底座尺寸 (cm)	PCS/CTN 装箱数量	G.W/N.W 毛净重(KG)	MEAS 箱规(cm)
CC-PP30	30	19 X 19 X 4.5	40	9.7/11.7	52 X 40 X 40
CC-PP40	40	24.5 X 24.5 X 3.6	20	8.6/10.6	52 X 26.5 X 44.5
CC-PP45	45	24.5 X 24.5 X 3.6	20	9.3/11.3	52 X 26.5 X 44.5
CC-PP50	50	24.5 X 24.5 X 3.6	20	10.0/12.0	52 X 26.5 X 44.5
CC-PP55	55	30.6 X 30.6 X 3.8	10	6.4/8.4	45 X 32.5 X 32.5
CC-PP60	60	30.6 X 30.6 X 3.8	10	6.8/8.8	45 X 32.5 X 32.5
CC-PP65	65	30.6 X 30.6 X 3.8	10	7.0/9.0	45 X 32.5 X 32.5
CC-PP70	70	30.6 X 30.6 X 3.8	10	7.2/9.2	45 X 32.5 X 32.5

### Product Packing & Accessories





## Orange Flexible Posts

### Product Description

1. Available in 450mm, 750mm high, the Lane-Flex has a model to suit most applications.
2. Our posts are the most durable and the brightest in the industry.
3. One piece moulded Polyurethane, TPR or EVA construction.
4. High performance reflectors.
5. Available in orange as standard. Custom colors available by special order.



Model 型号	Height (cm)	Base Diameter (cm)	Reflective Collars Size (cm)	Weight (KG)	PCS/M <sup>3</sup>	Reflective Color
CC-E01	45	20	7.1 X 2	0.45	150	Yellow/white
CC-E02	75	20	7.1 X 3	1.3	88	Yellow/white
CC-E03	75	20	7.1 X 3	0.55/0.63/0.8/0.9	88	Yellow/white
CC-E10	45	20	7.1 X 2	0.16	150	Yellow/white
CC-E11	75	20	7.1 X 3	0.30	100	Yellow/white
CC-E12	45	20	7.1 X 2	0.6	150	Yellow/white
CC-E14	86	20	7.5 X 3	0.7/1.3	87	Yellow/white
CC-E15	100	20	5.8 X 4	1.5	75	Yellow/white

## Rubber Base Flexible Posts / Spring-Back Flexible Posts

### Product Description

1. Hy-Last, heavy duty elastic rubber, one piece molded base.
2. Damaged posts are replaced quickly & easily, The link joint in this post enables it to recover after being hit or run over many times.
3. Material selection and design features enable the Lane-Flex to endure the harshest conditions and punishments.
4. It comes in many sizes with reflective options to meet all types of traffic control needs.
5. Our posts are the most durable and the brightest in the industry.
6. In low light conditions or at dark, gray winter days when visibility is limited, our fluorescent posts stand out boldly and help more effectively guide motorists.



Model 型号	Height (cm)	Base Diameter (cm)	Reflective Collars Size (cm)	PCS/M <sup>3</sup>	Material
CC-E04	50	26	15	100	Post:PE Base:Rubber
CC-E05	80	26	30	75	Post:PE Base:Rubber
CC-E06	120	26	45	55	Post:PE Base:Rubber
CC-E07	80	26	45	60	Post:PE Base:Rubber
CC-E08	100	26	45	50	Post:PE Base:Rubber
CC-E13	110	20	/	78	Post:PE Base:Plastic
CC-E13-1	65	10	20	/	Post:PE Base:Plastic
CC-E13-2	66	20	20	/	Post:PE Base:Plastic

## 柱式诱导标 Traffic Delineator / T-Top Stacker Cone

### Product Description

1. Delineator posts are made of flexible yet durable fluorescent low density polyethylene material, with UV inhibitors to minimize fading.
2. Rubber base is made from 100% recycled rubber, and is easy storage.
3. Convenient T-handle and molded in bolt hole for barricade lights, plastic chain, barricade tape or rope.
4. Improved recesses create a deeper area for reflective bands – stronger ribs provide maximum band protection.
5. Heavy duty base available in 6kg (standard) or 8kg (extra heavy).
6. Company name stenciling available.



Model:CC-F01  
Height:1100mm  
Base size:420x420mm  
Base weight:5kg,6kg or 8kg  
Post weight:0.8kg  
PCS/M<sup>2</sup>:45PCS

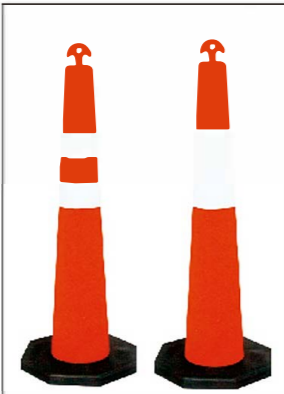

Model:CC-F02  
Height:1100mm  
Weight(total):9kg  
Base size:420x420mm  
Base weight:8kg  
Post weight:1kg  
PCS/M<sup>2</sup>:55PCS



Model:CC-F03  
Height:850mm  
Weight(total):0.48kg  
Base size:285x285mm  
Base weight:0.3kg  
Post weight:0.18kg



Model:CC-F04  
Size:720mm  
Weight(total):1.3kg  
Base size:200mm  
Reflective collars size:90mm



Model:CC-F06  
Height:1220mm  
Weight(total):1.8kg  
Single face or Double-faced  
Color:White body with Yellow or White reflector

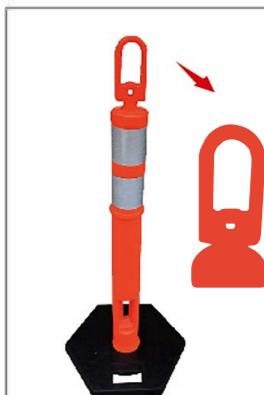

Model:CC-F07  
Height:1100mm  
Base size:420x420mm  
Base weight:6kg  
Post weight:0.8kg  
PCS/M<sup>2</sup>:45PCS



Model:CC-F08  
Height:1200mm  
Base size:760x350x50mm  
Base weight:14.5kg  
Post weight:0.9kg

## 塑料警示板 Vertical Panels



Model:CC-K04  
Height:1100mm  
Weight(total):13.0kg  
Base size:500x500mm  
Bottom width:320mm



Model:CC-K05  
Height:1100mm  
Weight(total):18kg  
Base size:400x700mm

## 塑料链条 Plastic Chain

### Product Description

Plastic chains are available in a variety of specifications and colors and can be produced in any length. They are mainly used for highway protection, aisle isolation in hotels, shopping malls, sports venues and public places. They can also be used to hang dolls in toy factories, hang clothes in clothing factories, and dry clothes at home.

1. It is both strong and durable.
2. Light weight, maintenance free and weather resistant.
3. It comes in a range of high visibility colours.
4. Wide array of colored chain suitable for a variety of both practical and decorative uses.

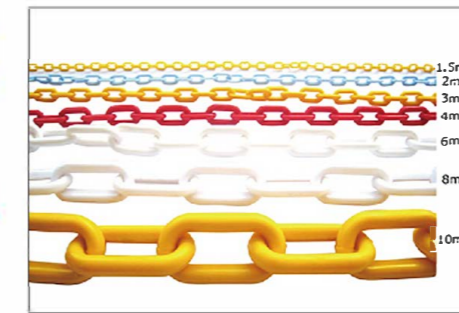
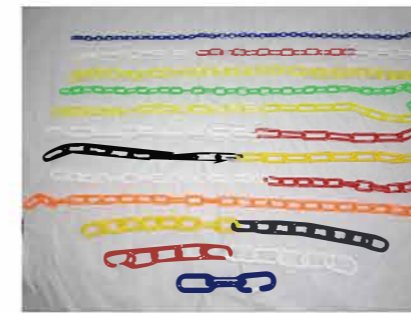

CC-C-Link  
Length(L):8cm  
Diameter(d):9mm  
Width(a):3cm  
Size:16PCS PER 1 METER  
Color: As requested

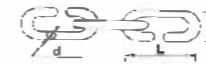

Model 型号	Diameter (mm) 直径	In-Length (mm) 内长	Out-Width (mm) 外宽	Weight/Meter(g) 重量/米	Section 截面
CC-P01	3	13	11	18	Round (圆)
CC-P02	4	27	16	40	Round
CC-P03	6	25	22	65	Round
		27	20	60	Flat(扁)
		41	21	60	Flat
CC-P04	8	38	27	110	Flat
		54	27	106	Flat
CC-P05	10	55	38	185	Round
CC-P06	12	65	40	300	Round

## 橡胶减速带 Reflective Recycled Rubber Speed Bumps

### 特点:

1. 独特的设计, 显著的减速效果, 从上面轧过无噪音, 无不舒适感。
2. 高精度橡胶制成, 结实, 耐用, 强抗撞击。
3. 根据客户需求灵活组合, 安装便捷。
4. 黄黑两色组合, 白天黑夜都能有效地吸引司机的注意力, 从而达到成功减速的效果。
5. 被广泛使用的最新减速产品之一。主要使用于城市十字路口, 高速公路交叉口, 收费站道口, 公园村庄入口, 停车场, 加油站等。

### Product Description

1. Molded from recycled rubber, tough, durable rubber material.
2. Available in black and yellow colours, the yellow is not painted on but yellow rubber compound compressed to the Bump.
3. Effective speed reduction.
4. Easily installed.
5. Contrasting colours and reflectors for visibility day & night.
6. Surface tread ensures grip even when wet.
7. Easily adjusted to site conditions.
8. Highly suitable for permanent & temporary installations.
9. Suitable for HGV's.



Model (型号): CC-B01  
Centre Section (尺寸): 1000x350x50mm, 1000x350x42mm, 250x350x45mm  
End Section (端头): 175x350x42/50mm



Model (型号): CC-B02  
Centre Section (尺寸): 500x350x50mm, 500x350x45mm  
End Section (端头): 175x350x45/50mm

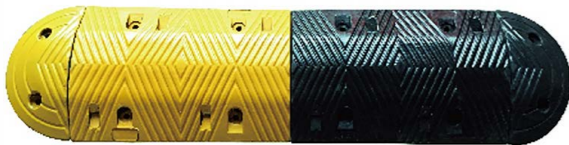

Model (型号): CC-B03  
Centre Section (尺寸): 500x330x70mm  
End Section (端头): 170x330x70mm



Model (型号): CC-B04  
Centre Section (尺寸): 1000x380x50mm  
End Section (端头): 190x380x50mm

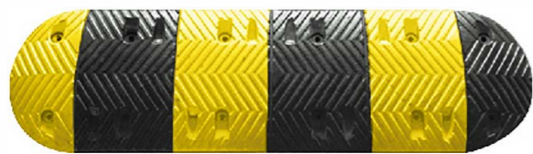

Model (型号): CC-B24  
Centre Section (尺寸): 1240x350x50mm



Model (型号): CC-B05  
Centre Section (尺寸): 500x425x70mm  
End Section (端头): 200x425x70mm



Model (型号): CC-B30  
Centre Section (尺寸): 1000x300x50mm  
End Section (端头): 170x300x50mm



Model (型号): CC-B27  
Centre Section (尺寸): 500x350x50mm  
End Section (端头): 175x350x50mm  
1 Channel: H29xW29mm



Model (型号): CC-B26  
Centre Section (尺寸): 1000x450x60mm  
End Section (端头): 250x450x60mm



Model (型号): CC-B06  
Centre Section (尺寸): 400x500x50mm  
End Section (端头): 400x150x50mm  
1 Channel: H25xW40mm



Model (型号): CC-B09  
Centre Section (尺寸): 500x500x25mm, 500x500x35mm, 500x500x50mm  
End Section (端头): 500x250x25mm, 500x250x35mm, 500x250x50mm

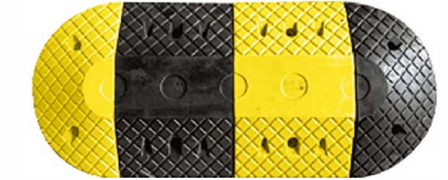

Model (型号): CC-B16  
Centre Section (尺寸): 250x400x70mm  
End Section (端头): 200x400x70mm  
1 Channel: H32xW58mm



Model (型号): CC-B31  
Centre Section (尺寸): 1000x300x60mm  
End Section (端头): 150x300x60mm  
2 Channel: H33xW34mm



Model (型号): CC-B32  
Centre Section (尺寸): 1000\*300\*50mm  
End Section (端头): 160\*300\*50mm  
1 Channel: H30xW35mm

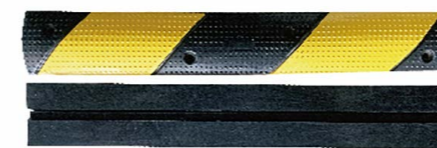

Model (型号): CC-B33  
Size (尺寸): 1000 x 150 x 30mm  
1 Channel: H20xW25mm

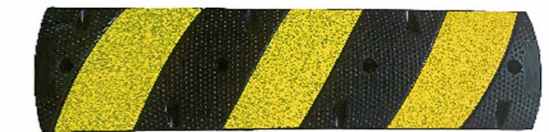

Model (型号): CC-B40  
Size (尺寸): 1200 x 300 x 60mm  
2 Channel: H30xW40mm



Model (型号): CC-B10  
Centre Section (尺寸): 1830\*300\*50mm  
1830\*300\*60mm  
End Section (端头): 190\*300\*50mm  
190\*300\*60mm



2 Channel: H31xW38mm

2 Channel: H25xW35mm

H:60mm

H:50mm

**NEW**

Model (型号): CC-B88

Centre Section (尺寸): 1000x300x40mm 1000x300x60mm

End Section (端头): 300x150x40mm 300x150x60mm



Model (型号): CC-B28

Centre Section (尺寸): 500x500x30mm 500x500x50mm

End Section (端头): 500x250x30mm 500x250x50mm



Model (型号): CC-BP01

Portable Speed Hump

Centre Section (尺寸): 3000x220x40mm



**塑料减速带 Yellow / Black Recycled Plastic Speed Bumps**



Model (型号): CC-B49

Centre Section (尺寸): 500x320x40mm

End Section (端头): 175x320x40mm



Model (型号): CC-B50

Centre Section (尺寸): 500x350x40mm

End Section (端头): 175x350x40mm

**盲道 Blind Road Brick**

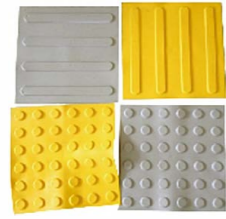

Model (型号): CC-M01

Material (材料): PVC

Size (尺寸): 300x300x0.7mm

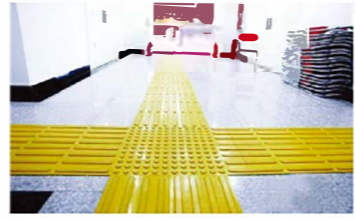

**橡胶减速带 Recycled Rubber Speed Humps**

**Product Description**

1. Made from 100% recycled rubber.
2. In-molded, reflective highway tape available in yellow or white.
3. Interlocking tongue and groove system allows module units to be linked together to cover the width of any roadway.
4. End caps are available to help protect modular ends as well as vehicles.
5. Can be easily removed for storage / relocation.
6. Can be used for temporary or permanent installation.
7. Resistant to moisture, oil, temperature variations, ultraviolet light.





Model (型号): CC-B07

Centre Section (尺寸): 600x500x30mm 600x500x50mm

End Section (端头尺寸): 600x225x30mm 600x225x50mm

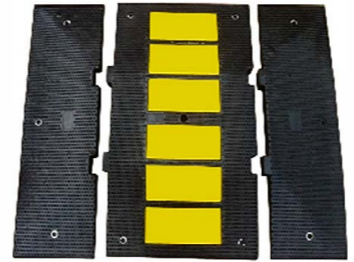
Reflective Tape Size: 120x120mm (反光带尺寸)

Model (型号): CC-B08

Centre Section (尺寸): 900x500x50mm

End Section (端头尺寸): 900x250x50mm

Reflective Tape: 110x250mm (反光条尺寸)



## 橡胶线槽减速带 Heavy Duty Cable Protectors

### Product Description

- 1.Safe, non-conductive PVC top with recycled rubber base.
- 2.Perfect solution for short-term events like fairs, trade shows and conventions.
- 3.Protect pedestrians from dangerous trip & fall hazards.
- 4.Protect expensive cables, cords & hoses from vehicle damage.
- 5.Easy placement & removal of cables/hose lines with open-top style.
- 6.Interlocking two-, three- & five-slot systems, to build the length you need.
- 7.Suitable for use with HGV's and forklift trucks.

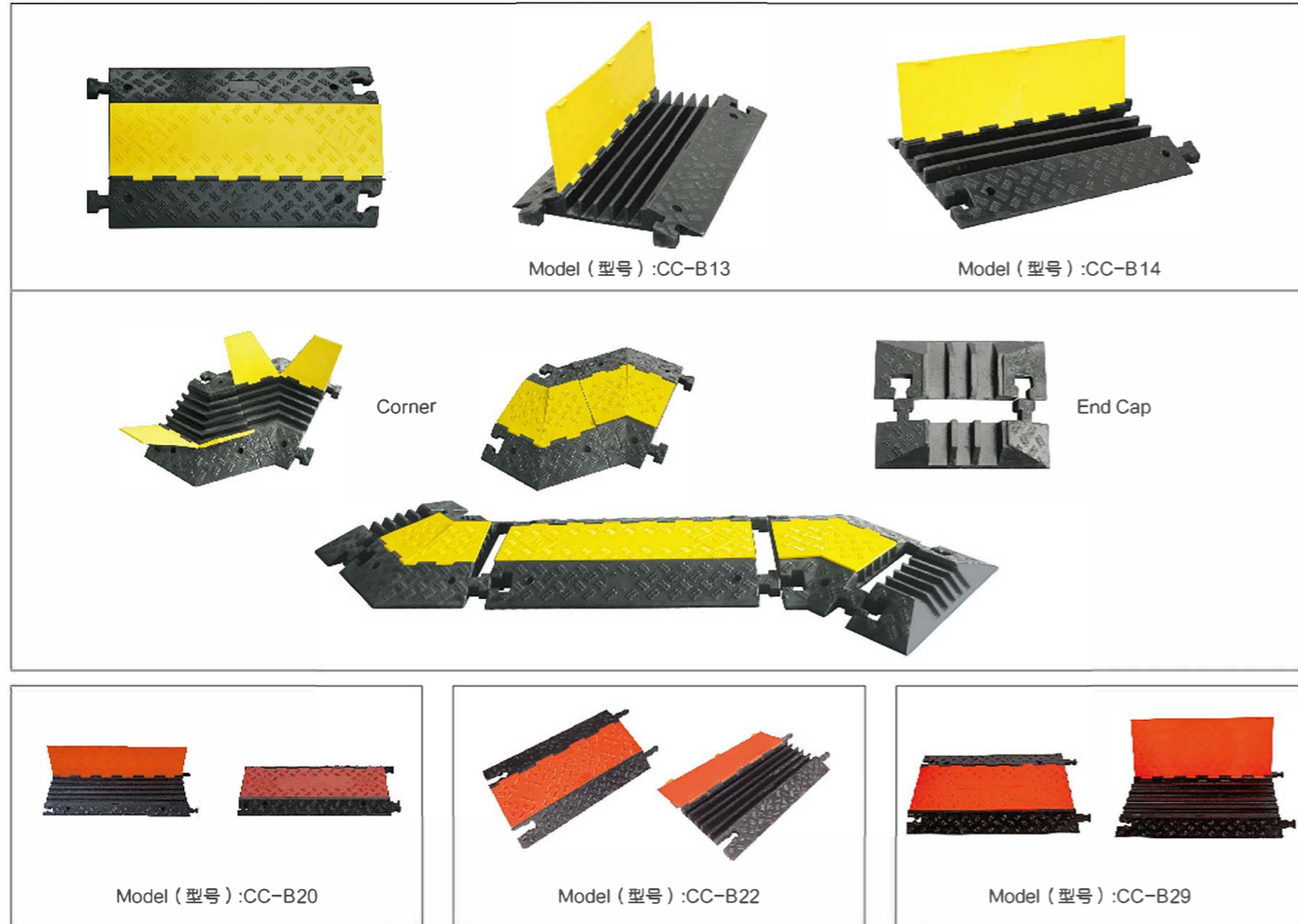

Model 型号	Part	Length (mm)	Width (mm)	Height (mm)	Channel	Channel Size (mm)	Material	Color
CC-B13	Centre section	900	600	75	5	(W)40 X (H)50	Body:Rubber Cover:Plastic	Body: Black Cover: Yellow
	Corner	620	600	75	5	(W)40 X (H)50		
	End Cap	200	600	75	5	(W)40 X (H)50		
CC-B14	Centre section	900	600	75	3	(W)60 X (H)50	Body: Rubber Cover: Plastic	Body: Black Cover: Yellow
	Corner	620	600	75	3	(W)60 X (H)50		
	End Cap	200	600	75	3	(W)60 X (H)50		
CC-B20	Centre section	910	430	31	5	(W)30 X (H)15	Body: Rubber Cover: Plastic	Body: Black Cover: Yellow / Red
CC-B22	Centre section	910	500	53	3	(W)28 X (H)38	Body: Rubber Cover: Plastic	Body: Black Cover: Yellow / Red
					2	(W)42 X (H)38		
CC-B29	Centre section	910	690	31	5	(W)50 X (H)17	Body: Rubber Cover: Plastic	Body: Black Cover: Yellow / Red



Model 型号	Part	Length (mm)	Width (mm)	Height (mm)	Channel	Channel Size (mm)	Material	Color
CC-B12	Centre section	900	500	70	3	(W)60 X (H)50	Body: Rubber Cover: Plastic	Body:Black Cover: Yellow/ Red
	End Cap	500	148/200	70	3	(W)60 X (H)50		
CC-B17	Centre section	1000	245	45	2	(W)25 X (H)30	Body: Rubber Cover: Plastic	Body:Black Cover: Yellow
CC-B18	Centre section	900	580	90	2	(W)95 X (H)70	Body: Rubber Cover: Plastic	Body:Black Cover: Yellow
CC-B19	Centre section	900	500	60	4	(W)45 X (H)40	Body: Rubber Cover: Plastic	Body:Black Cover: Yellow
CC-B21	Centre section	1000	300	45	3	(W)35 X (H)30	Body: Rubber Cover: Plastic	Body:Black Cover: Yellow
CC-B41	Centre section	1000	240	45	2	(W)33 X (H)35	Body: Rubber Cover: Plastic	Body:Black Cover: Yellow

**橡胶线槽减速带 Drop Over Cable Protectors**

**Product Description**

1. Tread plate surface provides maximum traction for pedestrian traffic.
2. These low profile protectors are compact for easy set up, disassembly, and storage.
3. For lightweight vehicles and pedestrian traffic.
4. Choose three colors: yellow/orange (for high visibility) or black (for a discreet look).
5. Connect alternating colors to enhance visual warning.

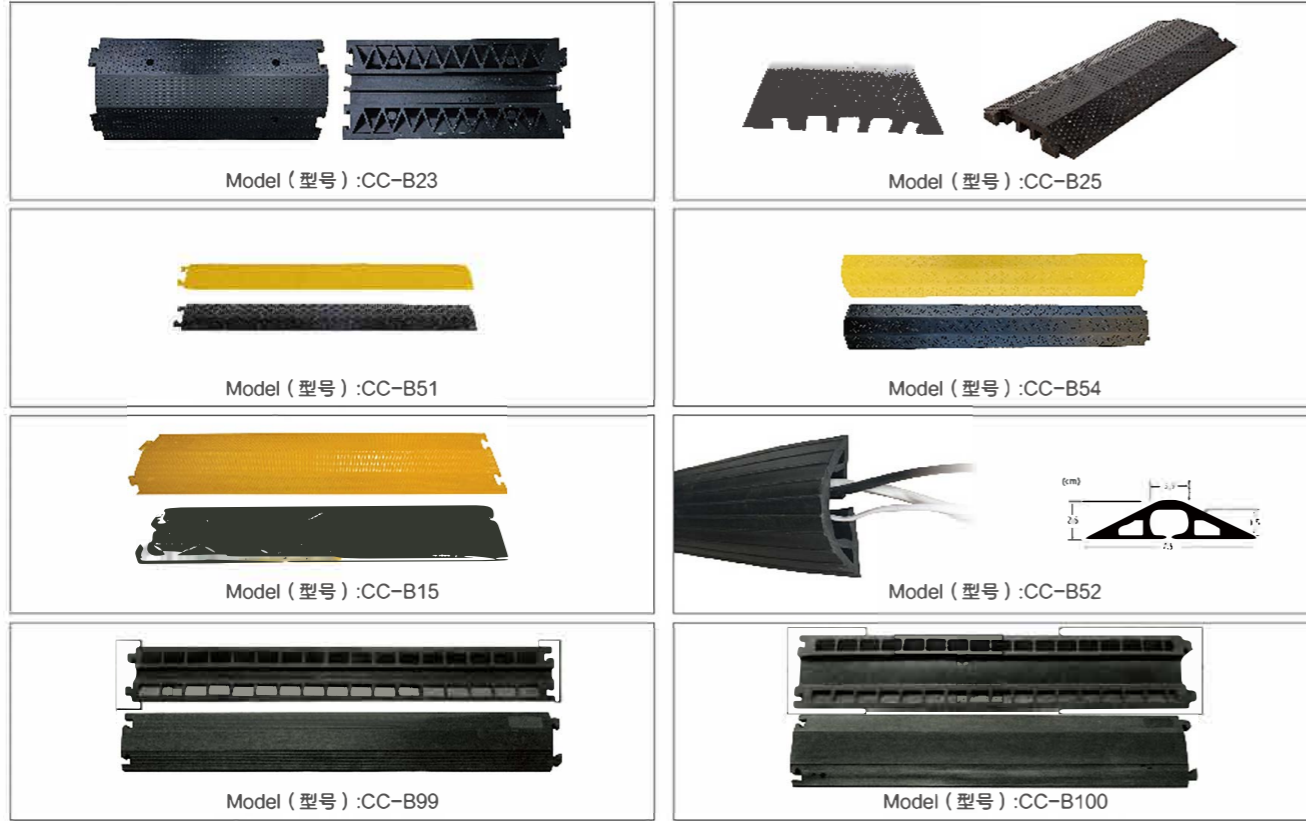

Model 型号	Part	Length (mm)	Width (mm)	Height (mm)	Channel	Channel Size (mm)	Material	Color
CC-B15	Centre section	1240	270	40	2	(W)45 X (H)25	rubber	Black/Yellow/Orange
CC-B23	Centre section	920	430	75	2	(W)60 X (H)55	rubber	Black
CC-B25	Centre section	930	370	55	3	(W)40 X (H)40	rubber	Black
CC-B51	Centre section	1000	130	20	1	(W)38 X (H)13	PVC	Black / Yellow
CC-B52	Centre section	-	75	25	1	(W)35 X (H)15	PVC	Black
CC-B54	Centre section	1000	250	40	1	(W)88 X (H)33	PVC	Black / Yellow
CC-B99	Centre section	1000	140	20	1	(W)30 X (H)10	rubber	Black
CC-B100	Centre section	1000	220	35	1	(W)90 X (H)25	rubber	Black

**橡胶减速垫 Rubber Speed Cushion**

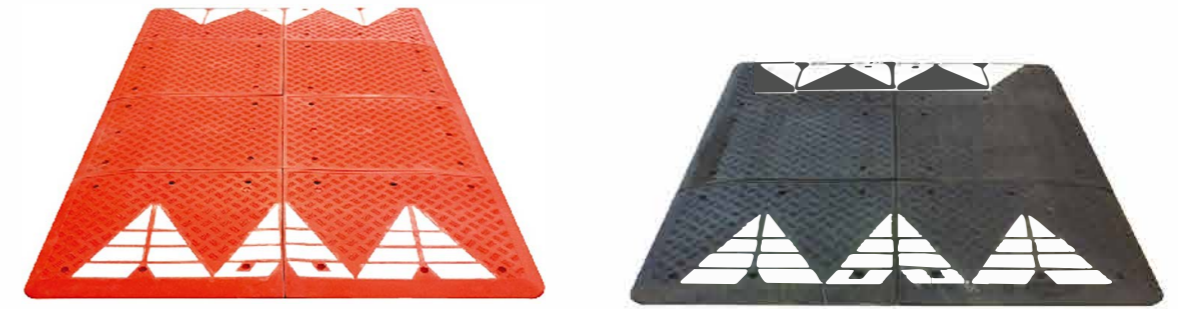

Model (型号) :CC-B68



Model 型号	Part	Length (mm)	Width (mm)	Height (mm)	Screw QTY (PCS)	Material	Color
CC-B68	Centre section	900	750	65	5	rubber	Red
	End section	900	750	65	6	rubber	
	Centre section	900	750	65	5	rubber	Black
	End section	900	750	65	6	rubber	

Remark: Assembled randomly, Usually assembled by 6 or 8pcs

### 橡胶车轮定位器 Striped Rubber Wheelstop / Parking Blocks

Rubber positioners are mainly installed on parking spaces to prevent the vehicle from hitting obstacles when parking backwards, thus protecting the vehicle and being a good partner for parking.

#### Product Description

- Made of 100% recycled rubber.
- For easy installation, each Parking Block is drilled before shipment.
- Highly visible & extremely durable.
- Temporary or permanent installation.
- Less damaging to vehicles upon impact.
- Molded in, Reflective tape ensures maximum visibility, even at night!
- Resistant to UV rays, moisture, oil & extreme temperatures.



Model 型号	Length 长度(mm)	Width 宽度(mm)	Height 高度(mm)
CC-D02	500	160	100
CC-D03	500	160	100
CC-D04	500	120	100
CC-D05	600	120	100
CC-D07	750	150	120
CC-D18	1000	160	100

### 橡胶车轮定位器 Striped Rubber Wheelstop / Parking Blocks



Model 型号	Length 长度(mm)	Width 宽度(mm)	Height 高度(mm)
CC-D08/CC-D08-1	1650	140	100
CC-D09	1830	150	100
CC-D11	900	150	100
CC-D19	550	150	100
CC-D20	1200	150	100
CC-D29	1650	160	100

**橡胶车轮定位器 Striped Rubber Wheelstop / Parking Blocks**



Model 型号	Length 长度(mm)	Width 宽度(mm)	Height 高度(mm)	Material 材质
CC-D13	550	150	100	Rubber
CC-D14	540	150	100	Rubber
CC-D15	560	150	80	Plastic
CC-D32	560	150	100	Rubber

**槽钢挡车器 Steel Wheel Stops**



Model (型号) :CC-D49  
Material: High quality steel pipe.  
Color: yellow/black.  
Pipe diameter(mm): 75  
Length (cm): 200  
Height (cm): 10  
Thickness(mm):1.5/1.8/2.0  
Remark: We can be customized according to customer needs.

**Wall Protector / Wall Guard**

**Product Description**

- 1.Strong, shock-absorbing, durable polyurethane foam.
- 2.Highly visible bright yellow with black stripes.
- 3.Prevent Personal Injury & Protect Walls, Machinery, Equipment.
- 4.Use indoors & outdoors in normal dry conditions.
- 5.Simple, Economical Fixing.
- 6.Tough, Reliable Performance.

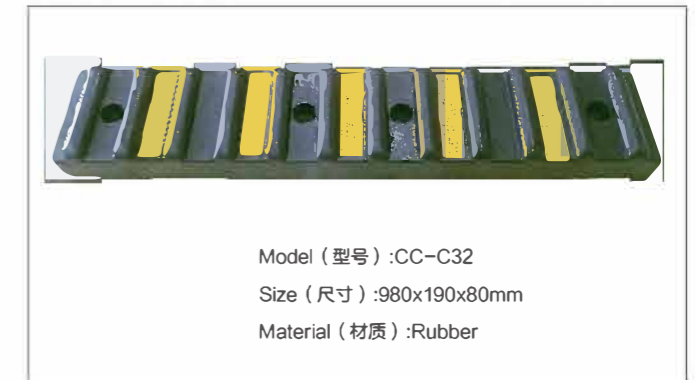
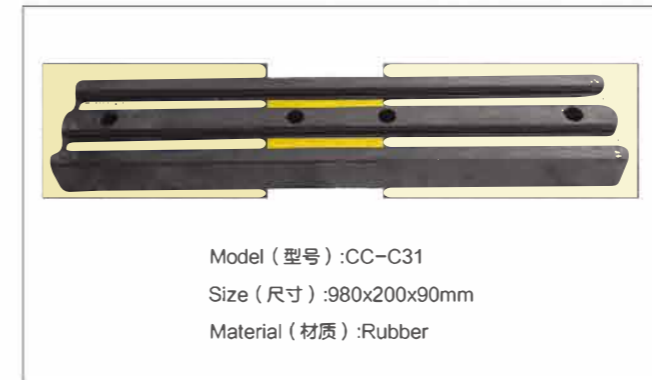



## Wheel Chocks

### Product Description

- 1、Keep equipment secure and ensure worker safety on worksites and in highway traffic areas from rolling equipment and vehicles.
- 2、Convenient carry handle ensures easy mobility.
- 3、Includes convenient molded carrying handle and accessory hole for ropes, chains, or mounting brackets.



Model (型号) :CC-D27

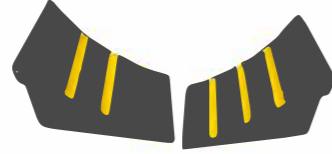

Model (型号) :CC-D12



Model (型号) :CC-D06



Model (型号) :CC-D16



Model (型号) :CC-D17



Model (型号) :CC-D23

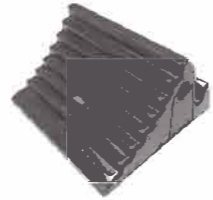

Model (型号) :CC-D28



Model (型号) :CC-D46



Model 型号	Length长度 (mm)	Width宽度 (mm)	Height高度 (mm)
CC-D06	240	165	195
CC-D12	250	160	190
CC-D16	200	100	150
CC-D17	270	120	180
CC-D23	230	150	175
CC-D27	255	245	185
CC-D28	300	260	150
CC-D46	250	200	150

## 道坡 Recycled Rubber Kerb Ramps / Curb Ramps

### Product Description

- 1、Made from 100% recycled rubber.
- 2、Ramps are reusable, easily stacked and transportable, saving even more for future jobs.
- 3、Also used to provide temporary ramp into driveways during construction along curbs.
- 4、Suitable for large and small vehicles including hand trolleys.



Model (型号) :CC-RR01



Model (型号) :CC-RR02



Model (型号) :CC-RR03



Model (型号) :CC-RR04



Model (型号) :CC-RR05



Model 型号	Length长度 (mm)	Width宽度 (mm)	Height高度 (mm)
CC-RR01	475	420	105
CC-RR02	480	320	130
CC-RR03	1000	250	40
CC-RR04	490	310	100
CC-RR05	500	270	135

## D-Type Dock Bumper



Model (型号) :CC-D30  
Size (尺寸) :1000x100mm  
Height (高度) :95mm  
Material (材质) :Rubber



Model (型号) :CC-C33  
Top Size (尺寸) :280x80mm  
Bottom Size (尺寸) :300x100mm  
Height (高度) :110mm  
Material (材质) :Rubber

## 橡胶护墙角 Rubber Corner Guard

Features: Made of high-quality rubber, high-brightness reflective film, black and yellow, easy to install, firm and durable.

### Product Description

1. Constructed from high impact resistant rubber.
2. Includes reflective yellow strips for visibility.
3. Designed to protect the corners of a building from damage.
4. Works great inside and outside.

5. This corner guard not only protects the structure and appearance of a building but also prevents scratches and dents to the vehicle.

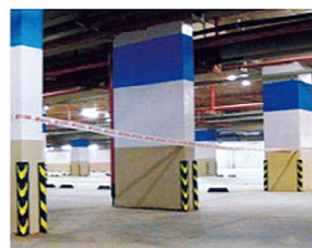

Model 型号	Height (mm)	Ply 厚度(mm)
CC-C01	600	10
CC-C02	800	8/10/12/14/16
CC-C03	900	9
CC-C04	600	20
CC-C05	800	20
CC-C06	1000	8/10/12

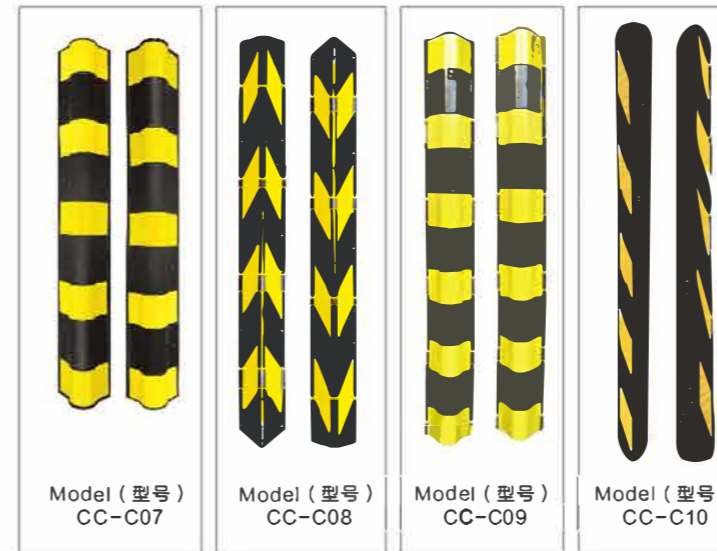

Model 型号	Height (mm)	Ply 厚度(mm)
CC-C07	1000	20
CC-C08	1200	10
CC-C09	1200	20
CC-C10	1500	13

## EVA Corner Guards / Plastic Corner Guards

### Product Description

1. Made of Plastic raw materials.
2. Non-toxic, durable and cold & hot resistant.
3. Easy installation and durable product.
4. Anti-bumping, shockproof, easy cleaning.
5. Available in different colours.



Model 型号	Height (mm)	Material 材质	Color 颜色
CC-C20	600	EVA	Red/Yellow/Black
CC-C21	800	EVA	Red/Yellow/Black
CC-C22	800	PE	Red/Yellow/Black
CC-C24	800	EVA	Black with reflective film

## 防撞桶、水马 Safety Barriers / Water Barriers / Road Barrier

### Product Description

One-time forming, cold-resistant, sun-proof, shock-resistant, and not easy to age; when filled with water, the water barrier will have better elasticity; without water, it is easy to move. At night, the reflective part is very conspicuous. Suitable for highway entrances, road bends, and toll booths to remind drivers to slow down.

1. Lightweight for easy loading & installation.
2. Fill with water or sand for "heavy-duty" use.
3. Polyethylene construction with reflective tape for high visibility.
4. Integrated lock of each barrier can be linked to line with any angle or barrier chain.



Model (型号): CC-S01



Model (型号): CC-S03



Model (型号): CC-S26



Model (型号): CC-S06



Model (型号): CC-S07



Model (型号): CC-S08

Model 型号	Product Name 产品名称	Height (mm)	Length (mm)	Top Width (mm)	Bottom Width (mm)	Water Capacity (KG)
CC-S01	Circ crashworthy bucket	800	Diameter:600	/	/	200
CC-S03	Roadside Barrier	560	560	150	350	60
CC-S26	Tack Barrier	250	1000	200	200	/
		180	1000	120	120	/
CC-S06	Blow Molding Single-hole Water Horse	650	1300	200	430	200
CC-S07	Blow Molding Double-hole Water Horse	650	1650	150	450	300
CC-S08	Blow Molding Three-hole Water Horse	780	1400	170	360	300



Model (型号): CC-S02



Model (型号): CC-S11



Model (型号): CC-S13

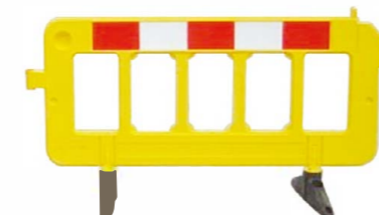

Model (型号): CC-S09



Model (型号): CC-S10



Model (型号): CC-S25



Model (型号): CC-S18



Model (型号): CC-S12



Model (型号): CC-S15



Model (型号): CC-S16

Model 型号	Product Name 产品名称	Height (mm)	Length (mm)	Top Width (mm)	Bottom Width (mm)	Water Capacity (KG)
CC-S02	Water Barrier	800	2000	145	400	400
CC-S09	Barrier	1000	2000	/	/	/
CC-S10	Plastic Roadside Barrier	1050	1500	/	/	/
			2000	/	/	/
CC-S11	Crashworthy Barrel	1100	Diameter:540	/	/	/
CC-S12	Traffic Barrel	1100	Barrel Diameter:580mm	Base Diameter:850mm	Material: PE Barrel,Rubber Base	
CC-S13	Foldable expandable Barricade	960	390-2400	/	/	/
CC-S25	Traffic Barrel	955	600	/	/	/
CC-S15	Traffic Barrel	900	Barrel Diameter:300-470mm	Base Diameter:570mm	Material: PE Barrel,Rubber Base	
CC-S16	Traffic Barrel	1060	Base Size:410*410mm		Material: PE	
CC-S18	Traffic Barrel	1000	Barrel Diameter:400mm(Top)		Barrel Diameter:505mm(Bottom)	

## 铁马铁护栏 METAL BARRIERS

### Product Description

- 1、 Temporarily manage foot traffic around job sites, festivals and sporting events.
- 2、 Barriers interlock to create long runs.
- 3、 Easy to set up and take down.
- 4、 Hook and eyes welded to sides.
- 5、 It is provided a highly visible, safe pedestrian barrier or traffic management system.

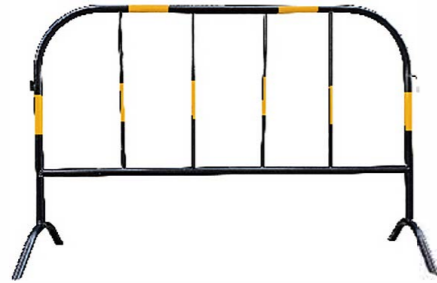

#### Model : CC-S21

Fastening: Hook Fastening  
Feet: Fixed Metal Feet  
Material: High quality steel pipe.  
Length (cm): 150  
Height (cm): 98  
Remark: We can be customized according to customer needs.



#### Model : CC-S22

Fastening: Hook Fastening  
Feet: Loose Leg (Loose legs supplied seperately)  
Material: High quality steel pipe.  
Length (cm): 150  
Height (cm): 101  
Remark: We can be customized according to customer needs.



#### Model : CC-S23

Fastening: Hook Fastening  
Feet: Fixed Metal Feet  
Material: High quality steel pipe.  
Length (cm): 150  
Height (cm): 98  
Remark: We can be customized according to customer needs.



## 伸缩护栏 Que Manager/Queue Belt Crowd Control Barrier

### Product Description

- 1、 Each post comes with its own belt assembly.
- 2、 Manual locking belt end clip.
- 3、 Ideal for indoor and outside use in establishments such as hotels, clubs and exhibition centers.
- 4、 They are suitable for crowd control purposes such as events queues and can easily be unhooked.



#### Model : CC-Q01

Retractable Belt Lengths: 2/3meter  
Height: 90CM  
Weight: 5.5KG  
Base Diameter: 31CM  
Material: Plastic  
Color: Red/Yellow/Green/Blue/White/Black



## 广角镜 Wide-angle Convex Mirror

### 特点:

适用于各种转角处。例如便利店、大型超市、马路拐角处、工厂、停车场等。广角镜耐磨损，抗紫外线照射，持久耐用，镜面图像清晰，安装便捷。

### 镜面材料:

进口的PC和丙烯酸

### 镜背面材料:

ABS 或者 抗老化树脂玻璃纤维。

### Product Description

1. 130 degree of viewing angle.
2. Lightweight, shatterproof and easily installed.
3. Includes mounting bracket and hardware.
4. Help avoid collisions at blind or obscured intersections.
5. They also assist supervision of machinery or production lines, giving that extra observation point.
6. Our range of mirrors are strong, stable and able to withstand all weather conditions without fading or cracking.



Model 型号	Specification 规格(cm)	Material of Mirror Face 镜面材料	Material of Mirror Back 镜背材料	MEAS(cm) 包装尺寸
CC-W30	30	PC	PE	39x8.6x39
CC-W45	45	PC	PE	49x9.5x49
CC-W60	60	PC	PE	61x10x61
CC-W80	80	PC	PE	84x14.5x84
CC-W100	100	PC	PE	100x14.5x100
CC-W120	120	PC	PE	122x19x122

## 告示牌 Safety Floor Signs / Floor Sign

### Product Description

1. Customization available using your own text.
2. Built-in carrying handle.
3. 2-sided floor sign has built-in hinge and folds flat for easy storage or transport on cars.
4. High visibility bright yellow color to warn employees or customers of a hazard.
5. These plastic portable, two-sided signs set up quickly in hazardous areas to warn bystanders of potential dangers.



## 防炫板 Antiglare Panel / Anti-dazzling Board



**太阳能交通警示灯 Solar Barricade Light**



**Model : CC-G08**

Luminous:4pcs super bright LED  
Material:PC Lens and ABS Base  
Power:0.4W solar panel  
Energy:1.2V 1500mAh NI-MH rechargeable battery  
Function:Flashing 70 ± 5 times per minute



**Model : CC-G09**

Luminous:6pcs super bright LED  
Material:PS Lens  
Power:0.4W solar panel  
Energy:2.4V 1000mAh NI-MH rechargeable battery  
Function:Flashing 70 ± 5 times per minute



**Model : CC-G12**

Luminous:2pcs super bright SMD LED  
Material:PS Lens and PP Base  
Power:0.4W solar panel  
Energy:1.2V 1500mAh NI-MH rechargeable battery  
Function:Flashing 95 ± 5 times per minute



**Model : CC-G13**

Luminous:6pcs super bright LED  
Material:PS Lens and PP Base  
Power:0.4W solar panel  
Energy:2.4V 1000mAh NI-MH rechargeable battery  
Function:Flashing 70 ± 5 times per minute

**交通路障灯 Barricade Lights / Flasher Lights**



**Model:CC-G01**

Luminous:2pcs super bright LED  
Material:PS Lens and PP Base  
Power:1 or 2PCS 4R25 6V battery  
Function:Flashing (70 ± 5 times per minute) and steady  
Without bracket



**Model:CC-G02**

Luminous:2pcs super bright LED  
Material:PS Lens and PP Base  
Power:1 or 2PCS 4R25 6V battery  
Function:Flashing (70 ± 5 times per minute) and steady  
With bracket



**Model:CC-G03**

Luminous:2pcs super bright LED  
Material:PS Lens and PP Base  
Power:1 PC 4R25 6V battery  
Function:Flashing (70 ± 5 times per minute) and steady  
Mount bracket is available



**Model:CC-G04**

Luminous:2pcs super bright LED  
Material:PS Lens and PP Base  
Power:2 PCS R20 1.5V battery  
Function:Quick flashing 3 times (70 ± 5 times per minute)and steady  
Mount bracket is available



**Model:CC-G05**

Luminous:2pcs super bright LED  
Material:PS Lens and PP Base  
Power:1or 2 PCS 4R25 6V battery  
Function:Flashing(70 ± 5 times per minute)and steady  
Mount bracket is available



Model : CC-G07

Luminous:6pcs bright LED or 1pc bulb  
Material:PS Lens and PP Base  
Power:1or 2 PCS 4R25 6V battery  
Function:Flashing(70±5 times per minute)and steady  
Mount bracket is available



Model : CC-G10

Luminous:2pcs super bright LED  
Material:PS Lens and PP Base  
Power:1PC 4R25 6V battery  
Function:Flashing(70±5 times per minutes)and steady

**电池: 6V 4R25 Battery: 6V 4R25**

**特点:**

- 1) 4R25/6V
- 2) 较好的防止泄漏
- 3) 规格齐全: D, C, AA, AAA, 9V, 4.5V and 6V 灯笼式电池



Model:CC-H01  
Weight: 0.5kg  
Color: Black



Model:CC-H02  
Weight: 0.5kg  
Color: Yellow



**Product Description**

- 1) 4R25/6V
- 2) Better protection against leakage
- 3) Full Sizes Available: D, C, AA, AAA, 9V, 4.5V and 6V lantern type battery



Aluminum foil detectable warning tape,  
Detectable warning tape



Warning tape,caution tape,  
barricade tape

**警示带 Warning Tape, Caution Tape, Barricade Tape**

**Product Description**

- 1、 A high quality, Hazard Warning Tape with a long lasting luminous effect for highlighting hazards in all light conditions and in difficult situations such as darkness and smoke.
- 2、 Manufactured from low density polyethylene to combine high tensile strength with maximum flexibility.
- 3、 Colourfast and long-lasting,cheap and effective.
- 4、 Available in a wide range of designs and colours.



Automatic Cutter

## 安全背心 Safety vest

Safety vests are made of high-visibility reflective materials, which enable traffic police and other operators to work smoothly at night or in special weather conditions, thereby reducing unnecessary casualties. In daily production and life, especially in traffic engineering, it plays a special role in safety protection.

### Product Description

- 1、 High visibility clothing for day & night use.
- 2、 Extremely comfortable to wear.
- 3、 Available in highly visible fluorescent Yellow or Orange.
- 4、 Reflective tape enhances visibility.
- 5、 Also available in EN 471 certifications.
- 6、 Various options of branding on vests available.
- 7、 This lightweight material is breathable and cool in hot weather yet durable enough for the construction industry.



Model (型号) :CC-V07

Fabric:100% polyester mesh/netting  
Tape:Normal-vis reflective tape  
Color:Fluorescent yellow/orange  
Size:S-3XL  
Closure:Zipper  
MEAS:100PCS/CTN/48x32x48cm  
G.W.:10KGS  
N.W.:9KGS



Model (型号) :CC-V08

Fabric:100% polyester tricot/knitting  
Tape:Hi-vis reflective tape(100G)  
Color:Fluorescent yellow/orange  
Size:S-3XL  
Closure:Zipper  
MEAS:100PCS/CTN/48x32x48cm  
G.W.:10KGS  
N.W.:9KGS



Model (型号) :CC-V09

Fabric:100% polyester mesh/netting  
Tape:Hi-vis PVC tape  
Color:Fluorescent yellow/orange  
Size:S-3XL  
Closure:Zipper  
MEAS:100PCS/CTN/48x32x48cm  
G.W.:10KGS  
N.W.:9KGS



Model (型号) :CC-V01

Conforms to EN471 Class2  
Fabric:100% polyester tricot/ knitting  
Tape:Hi-vis reflective tape(120G)  
Color:Fluorescent yellow/orange  
Size:S-3XL  
Closure:Velcro  
MEAS:100PCS/CTN/48x32x48cm  
G.W.:16KGS  
N.W.:14KGS



Model (型号) :CC-V02

Conforms to EN471 Class2  
Fabric:100% polyester tricot/knitting  
Tape:Hi-vis reflective tape(120G)  
Color:Fluorescent yellow/orange  
Size:S-3XL  
Closure:Velcro  
MEAS:100PCS/CTN/47x32x45cm  
G.W.:17KGS  
N.W.:15KGS



Model (型号) :CC-V03

Conforms to EN471 Class2  
Fabric:100% polyester tricot/knitting  
Tape:Hi-vis reflective tape(120G)  
Color:Fluorescent yellow/orange  
Size:S-3XL  
Closure:Velcro  
MEAS:100PCS/CTN/48x32x48cm  
G.W.:16KGS  
N.W.:14KGS



Model (型号) :CC-V04

Fabric:100% polyester mesh/netting  
Tape:Normal-vis reflective tape  
Color:Fluorescent yellow/orange  
Size:S-3XL  
Closure:Velcro  
MEAS:200PCS/CTN/43x24x70cm  
G.W.:10KGS  
N.W.:9KGS



Model (型号) :CC-V05

Conforms to EN471 Class2  
Fabric:100% polyester tricot/knitting  
Tape:Hi-vis reflective tape(120G)  
Color:Fluorescent yellow/orange  
Size:S-3XL  
Closure:Zipper  
MEAS:50PCS/CTN/44x24x32.5cm  
G.W.:8.6KGS  
N.W.:8.1KGS



Model (型号) :CC-V06

Fabric:100% polyester mesh/netting  
Tape:Hi-vis PVC tape  
Color:Fluorescent yellow/orange  
Size:One size fits all  
Closure:Velcro  
MEAS:100PCS/CTN/57x45x30cm  
G.W.:22KGS  
N.W.:20KGS



## 分道体 Lane Separator / Lane Divider

### Product Description

1. Quickly and easily installed.
2. Highly visible reflective panels.
3. Strong indication of traffic lanes.
4. Can also be left unanchored for a temporary, flexible traffic control device.
5. Creates a dramatic picket fence effect, increases the visual barrier.



Model:CC-K01  
TTL Height:325mm  
Panel Size:Bottom Width115\*Top Width:80mm  
Base Size:L210\*W150\*H29mm



Model:CC-K03  
Height:770mm  
Base size:995x208mm



## 陶瓷道钉 Ceramic Road Studs

### Product Description

1. Its surface via glazed finish protection to resist weathering especially during rain, excellent daytime visibility.
2. Color in Hi-Vision white or yellow, available in different diameter.
3. A texture bottom helps it in place with epoxy glue.



Model 型号	Specification 规格	Color 颜色	Reflector 反光片	QTY(PCS) 数量	MEAS(CM) 包装尺寸
CC-RS01	4"	Yellow or White	without	60	34x27x22
CC-RS02	6"	Yellow or White	without/ Single-way/ Double-way	16	34x34x34
CC-RS03	8"	Yellow or White	without/ Single-way/ Double-way	10	43x35x32

## 塑料道钉 Plastic Road Studs



Model 型号	Specification 规格(mm)	Color 颜色	Reflector 反光片	QTY(PCS) 数量	MEAS(CM) 包装尺寸
CC-PS01	100x100x20	Yellow or White	Single-way	100	52.3x21.2x22.5
CC-PS02	100x100x20	Yellow or White	Double-way	100	52.3x21.2x22.5
CC-PS03	100x100x20	Yellow or White	Single-way or Double-way	100	52.3x21.2x22.5
CC-PS04	100x100x20	Yellow or White	Single-way or Double-way	100	52.3x21.2x22.5
CC-PS05	Dia165	Yellow	/	40	67x56x17
CC-PS06	Dia215	Yellow	/	40	87x69x22
CC-PS07	L100xH50	Yellow	/	400	55x30x12
CC-PS08	L50xH50	Yellow	/	800	55x30x12
CC-PS09	Dia105	Yellow	/	200	81x54x11.5

## 铝道钉 Aluminum Road Studs



Model 型号	Specification 规格(mm)	Color 颜色	Reflector 反光片	QTY(PCS) 数量	MEAS(CM) 包装尺寸
CC-ALS01	100x100x20	Yellow or White	Single-way or Double-way	50	16.5x29.5x17.5
CC-ALS02	100x100x20	Yellow or White	Single-way or Double-way	50	16.5x29.5x17.5

### 太阳能道钉 Solar Road Studs



Model 型号	Specification 规格(mm)	LED QTY(PCS) LED数量	Material 材质	Battery 电池	QTY(PCS) 数量	MEAS(CM) 包装尺寸
CC-SRS02	110x90x23	2*3 (Red/Yellow/Green)	Aluminum Alloy+PC	Ni-MH 800mAH	60	41x28x28.5
CC-SRS04	103x103x23	2*2 (Red/Yellow/Green)	Aluminum Alloy+PC	Ni-MH 800mAH	60	41x28x28.5
CC-SRS05	103x103x23	2*3 (Red/Yellow/Green)	Aluminum Alloy+PC	Ni-MH 800mAH	60	41x28x28.5
CC-SRS06	110x97x24	6 (Red/Yellow/Green/Blue/White)	Aluminum Alloy+PC	Ni-MH 600mAH	50	38x25.5x29.5
CC-SRS07	125x25	3/6 (Red/Yellow/Green/Blue/White)	PC	Ni-MH 600mAH	50	38x25.5x29.5
CC-SRS08	105x105x25	4(Red/Yellow/Green/Blue/White)	Aluminum Alloy+PC	Ni-MH 600mAH	50	38x25.5x29.5
CC-SRS09	105x105x25	6 (Red/Yellow/Green/Blue/White)	Aluminum Alloy+PC	Ni-MH 600mAH	50	38x25.5x29.5
CC-SRS10	128x118x78	6 (Red/Yellow/Green/Blue/White)	Aluminum Alloy+PC	Ni-MH 600mAH	20	70x28.5x22
CC-SRS12	104x123x23	4(Red/Yellow/Green/Blue/White)	Shell-Aluminium Lens-Polycarbonate	Li 3.7V/500mAH	50	58.5x27x18

### 反光指挥棒 & LED闪光棒 Traffic Baton / Traffic Wands



Model 型号	Specification 规格(cm)	Function 功能	Battery 电池	QTY(PCS) 数量	MEAS(CM) 包装尺寸
CC-RB01	(L)41x(DIA)4	Flash - Steady - Closed	Two D Batteries	60	46x35x57
CC-RB02	(L)54x(DIA)4	Flash - Steady - Closed	Two D Batteries	50	57x28x54
CC-RB03	(L)87x(DIA)4	Flash - Steady - Closed	Two D Batteries	48	92x36x46
CC-RB04	(L)41x(DIA)4	Flash - Steady - White Light - Closed	Two D Batteries	50	46x35x57
CC-RB05	(L)54x(DIA)4	Flash - Steady - White Light - Closed	Two D Batteries	50	57x28x54

### 警示三角牌 Safety Triangles / Warning Triangle



CC-WT01 CC-WT03 CC-WT04 CC-WT05



CC-WT06 CC-WT07 CC-WT08 CC-WT09

Model 型号	Specification 规格(cm)	Certificate 证书	Material 材质	QTY(PCS) 数量	MEAS(CM) 包装尺寸
CC-WT01	43x43x43	E-Mark	PS	20	46x32x32
CC-WT03	43x43x43	CE	PS	20	46x32x32
CC-WT04	43x43x43	E-Mark	PS	30	45x17x24
CC-WT05	43x43x43	E-Mark CE	PS	20	44.5x19.5x27
CC-WT06	43x43x43	E-Mark	PS	30	45x22x29.5
CC-WT07	41x41x41	/	PS	50	42x27x40
CC-WT08	42x42x42	/	PS	50	41.5x42x26
CC-WT09	26x26x26	/	PS	80	45x33x33

## 安全帽/安全头盔 Safety Helmets / Hard Hats

### Product Description

- 1.Offers side (lateral) impact protection, as well as side penetration protection.
- 2.Ratchet suspension allows user to adjust while wearing.
- 3.Easy to clean with warm water and soap.
- 4.They are designed to protect against falling objects in factory or building site.
- 5.The attachment slots for use with ear muffs or face shields.
- 6.The head band is adjustable for a sure,comfortable fit.
- 7.They are easy to use and lightweight.

Photo	Model	Style	Weight	QTY(PCS) 数量	MEAS(CM) 包装尺寸	MARKS
<b>ABS Material</b>						
	CC-SHA01	V Design	435g	40	52x46x60	CE CERTIFICATION
	CC-SHA02	V Design	384g	50	52x46x60	CE CERTIFICATION
	CC-SHA03	Permeable V Design	390g	45	52x46x60	CE CERTIFICATION
	CC-SHA04	Edge curl Design	357g	50	52x46x60	CE CERTIFICATION
<b>HDPE Material</b>						
	CC-SHP01	V Design	344g	40	52x46x60	CE CERTIFICATION
	CC-SHP02	V Design	327g	50	52x46x60	CE CERTIFICATION
	CC-SHP03	V Design	262g	60	52x46x60	/
	CC-SHP04	V Design	334g	60	52x46x63	/

We provide one-stop traffic safety equipment solutions to meet your full range of needs.



### Service

We focus on developing high-quality products for topend markets. Our products are in line with international standards, and are mainly exported to Europe, America, Japan and other destinations around the world.



### Customization

We have a R&D team that can produce products according to the drawings provided by customers.



### Capacity

Our annual production capacity is over 20000 tons, we can meet the needs of different customers with different purchase quantity.

We have advanced testing equipment in the industry to ensure product quality.

